



# RocketDish™

airMAX® 2x2 PtP Bridge Dish Antenna

Models: RD-2G24, RD-3G26, RD-5G30, RD-5G30-LW, RD-5G34

Powerful Performance for Long-Range Links

---

Robust Design and Construction for Outdoor Use

---

Seamless Integration with Rocket Radios



# Overview

Pair a RocketDish™ antenna with a Rocket® basestation to create the endpoint of a high-performance, Point-to-Point (PtP) bridge or network backhaul (Rocket sold separately).

The RocketDish is available in the following frequency models:

- 2.4 GHz
- 3 GHz
- 5 GHz

## Powerful Performance

The RocketDish antenna delivers 2x2, dual-polarity performance. On the right is one example of how the RocketDish with Rocket can be deployed in a backhaul link to deliver bandwidth from an ISP network out to a neighborhood tower. From there, an airMAX® Sector with Rocket delivers bandwidth to the ISP's customers.

## Carrier-Class Construction

Incorporating a dish reflector design for excellent beam directivity, the RocketDish antennas feature robust mechanical design using industrial-strength hardware for outdoor application use.

## Plug and Play Integration

RocketDish antennas and Rocket basestations have been designed to seamlessly work together. Every RocketDish has a built-in Rocket mount, so installation requires no special tools.

Snap the Rocket securely into place and mount the antenna; you then have the optimal combination of RocketDish and Rocket for your PtP application.

## Application Example

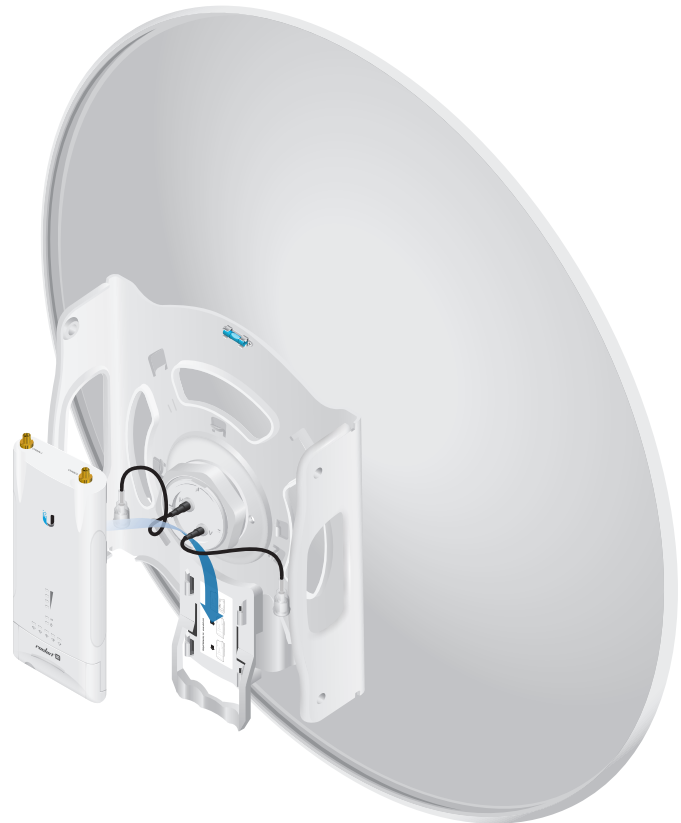
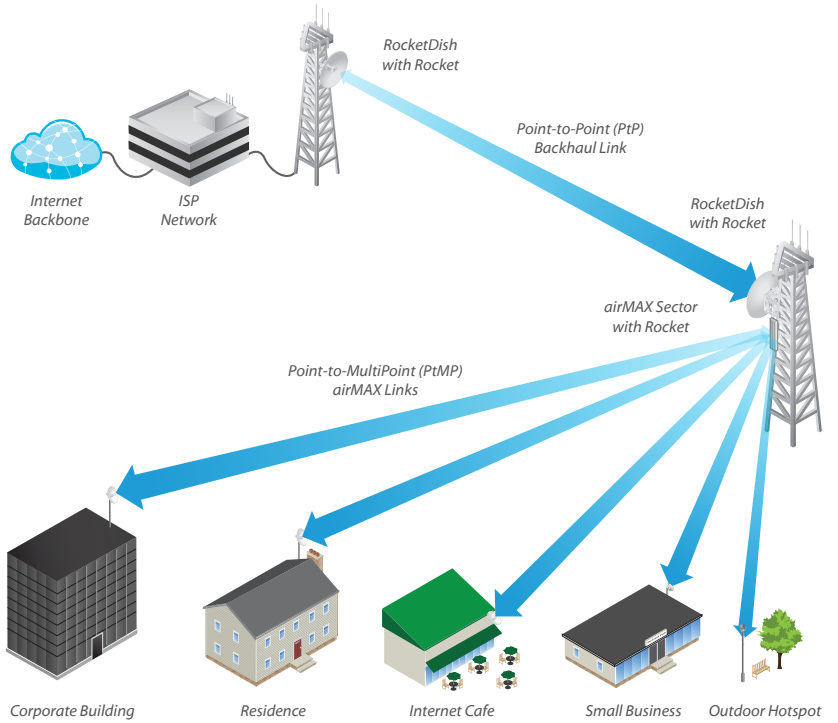

Mounting a Rocket on the RD-5G30-LW

# Hardware Overview

## Innovative Mechanical Design

- **Secure pole-mounting** The hardware is designed to securely mount and maintain the position of the dish during harsh outdoor conditions.
- **Convenient installation** The bubble level allows for easy alignment.
- **Precision elevation adjustment of the RD-5G30-LW** Use this new feature to quickly fine-tune and adjust the elevation.

## Weatherproof Design

- **Protective shroud** The shroud\* protects the cables and connectors from nature's elements.
- **Mounting hardware of the RD-5G30-LW** Made of galvanized steel that is powder-coated for superior corrosion resistance.
- **Fasteners of the RD-5G30-LW** GEOMET-coated for improved corrosion resistance when compared with zinc-plated fasteners.

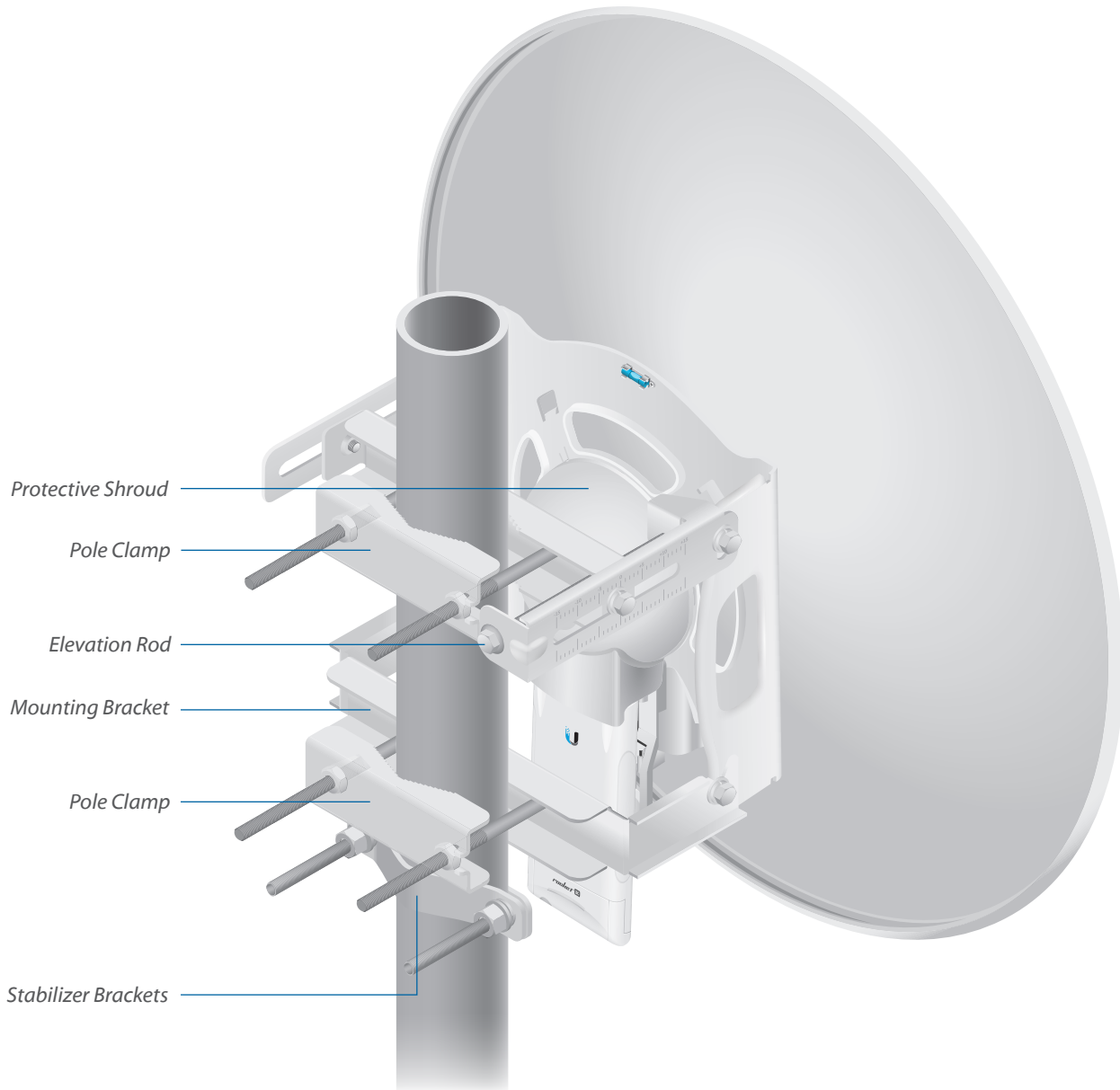

*Back View of the Fully Assembled RD-5G30-LW*

\* All models except for the RD-2G24 include a shroud.

## 2.4 GHz Model

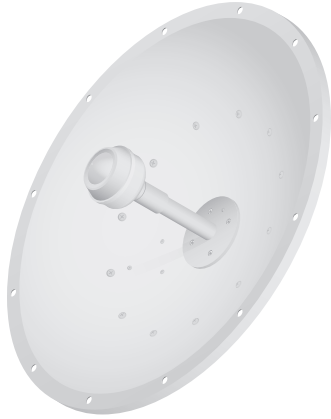

Model	Frequency	Gain	Radome*
RD-2G24	2 GHz	24 dBi	RAD-RD2

The 2.4 GHz frequency band is free to use, worldwide; however, it is extremely crowded due to interference from other wireless devices. Also, there are only three non-overlapping, 20 MHz channels available for use.

## 3 GHz Model



Model	Frequency	Gain	Radome*
RD-3G26	3 GHz	26 dBi	RAD-RD2

The 3 or 3.65 GHz frequency band is noise-free in most areas; however, its use requires a license. There may be additional restrictions on its use depending on local country regulations.

## 5 GHz Models



Model	Frequency	Gain <sup>1</sup>	Radome <sup>2</sup>
RD-5G30	4.9 - 5.8 GHz	26 - 30 dBi	RAD-RD2

The 5 GHz frequency band is free to use, worldwide, offers plentiful spectrum, and works well for long-distance links. However, 5 GHz signals have more difficulty passing through obstacles than lower-frequency signals.

The 4.9 GHz frequency band typically requires a license and is reserved for public safety applications.



Model	Frequency	Gain	Radome <sup>2</sup>
RD-5G30-LW	5.1 - 5.9 GHz	30 dBi	ISO-BEAM-620

The RD-5G30-LW features the same gain as the RD-5G30 and adds the following advantages:

- Lightweight yet robust components lessen the load.
- The extended depth of the dish reflector rejects noise interference in co-location deployments.
- The design of the mounting bracket allows for ease of installation on a pole or tower.



Model	Frequency	Gain <sup>1</sup>	Radome <sup>2</sup>
RD-5G34	4.9 - 5.8 GHz	30 - 34 dBi	RAD-RD3

The RD-5G34 offers up to 34 dBi of gain in a 1050-mm diameter size.

<sup>1</sup> Check your local/regional regulations for the maximum antenna gain allowed for your application.

<sup>2</sup> A radome is available as an optional accessory.

# RocketDish™ Radome

Models: RAD-RD2, RAD-RD3



Model	RD-2G24	RD-3G26	RD-5G30	RD-5G30-LW	RD-5G34
RAD-RD2	✓	✓	✓		
RAD-RD3					✓

A protective radome is available as an optional accessory for the RD-2G24, RD-3G26, RD-5G30, and RD-5G34. The RAD-RD2 or RAD-RD3 provides the following advantages:

- Reduces wind load
- Protects antenna surfaces from nature’s harshest elements
- Conceals antenna feed equipment from public view

# airFiber® X Conversion Kit

Model: AF-5G-OMT-S45



Model	RD-2G24	RD-3G26	RD-5G30	RD-5G30-LW	RD-5G34
AF-5G-OMT-S45			✓		✓

The RocketDish to airFiber® Antenna Conversion Kit converts the RocketDish RD-5G30 or RD-5G34 antenna to 45° slant polarity for use with the AF-5X or AF-4X.



# RocketDish™ LW Accessories IsoBeam™

Model: ISO-BEAM-620



The IsoBeam™ is an isolator radome that is available as an optional accessory for the RD-5G30-LW and two PowerBeam® models:

- PBE-5AC-620
- PBE-M5-620

The innovative RF-choke perimeter of the IsoBeam delivers superior noise immunity in co-location deployments; its perimeter corrugation provides enhanced RF shielding. Compare the two near-field plots below, and note the breakthrough isolation performance of the IsoBeam.

Both near-field plots are displayed in watts and use a linear scale. The strength of the electromagnetic field is color-coded:

- Red: Highest strength
- Green: Medium strength
- Indigo: Lowest strength

Without IsoBeam

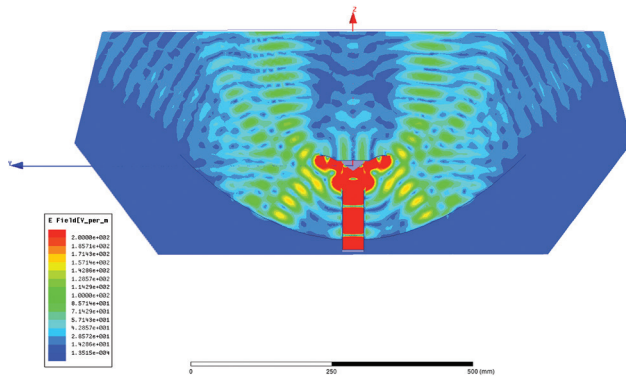

With IsoBeam

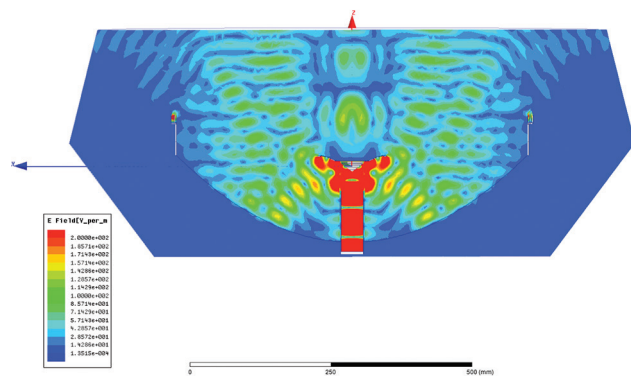

## Precision Alignment Kit

Model: PAK-620

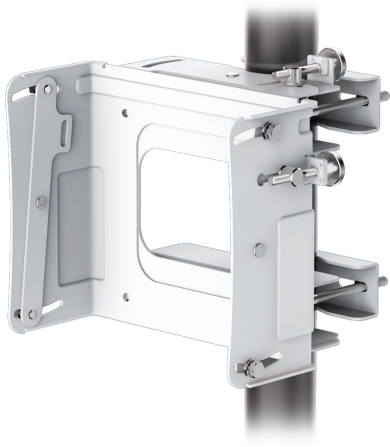

The Precision Alignment Kit is available as an optional accessory for the RD-5G30-LW. It features 15° of azimuth adjustment and 15° of elevation adjustment to enable extremely accurate aiming for optimal PtP link performance.

The Precision Alignment Kit is also compatible with other dish antennas:

- airFiber AF-5G30-S45
- PowerBeam PBE-5AC-620
- PowerBeam PBE-M5-620

## Specifications

Antenna Characteristics					
Model	RD-2G24	RD-3G26	RD-5G30	RD-5G30-LW	RD-5G34
Dimensions*	650 x 650 x 295 mm (25.6 x 25.6 x 11.61")	650 x 650 x 300 mm (25.6 x 25.6 x 11.81")	650 x 650 x 304 mm (25.6 x 25.6 x 11.97")	650 x 650 x 386 mm (25.6 x 25.6 x 15.2")	1050 x 1050 x 421 mm (41.34 x 41.34 x 16.57")
Weight**	9.8 kg (21.61 lb)	9.8 kg (21.61 lb)	9.8 kg (21.61 lb)	7.4 kg (16.31 lb)	13.5 kg (29.76 lb)
Frequency Range	2.3 - 2.7 GHz	3.3 - 3.8 GHz	4.9 - 5.8 GHz	5.1 - 5.9 GHz	4.9 - 5.8 GHz
Gain	24 dBi	26 dBi	4.9 GHz: 26 dBi 5 - 5.9 GHz: 30 dBi	30 dBi	4.9 GHz: 30 dBi 5 - 5.8 GHz: 34 dBi
HPOL Beamwidth	6.6° (3 dB)	7° (3 dB)	5° (3 dB)	5.8° (3 dB)	3° (3 dB)
VPOL Beamwidth	6.8° (3 dB)	7° (3 dB)	5° (3 dB)	5.8° (3 dB)	3° (3 dB)
F/B Ratio	28 dB	33 dB	34 dB	30 dB	42 dB
Max. VSWR	1.6:1	1.4:1	1.4:1	1.6:1	1.4:1
Wind Loading	787 N @ 200 km/h (177 lbf @ 125 mph)			790 N @ 200 km/h (178 lbf @ 125 mph)	1,779 N @ 200 km/h (400 lbf @ 125 mph)
Wind Survivability	200 km/h (125 mph)				
Polarization	Dual-Linear				
Cross-pol Isolation	35 dB Min.				
ETSI Specification	EN 302 326 DN2				
Mounting	Universal Pole Mount, Rocket Bracket, and Weatherproof RF Connectors Included				

\* Dimensions exclude pole mount and Rocket (Rocket sold separately)

\*\* Weight includes pole mount and excludes Rocket (Rocket sold separately)



## RD-2G-24 Antenna Information

Return Loss

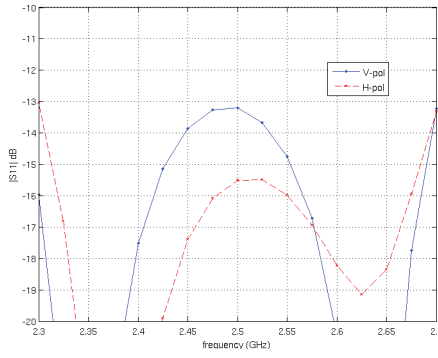

Vertical Azimuth

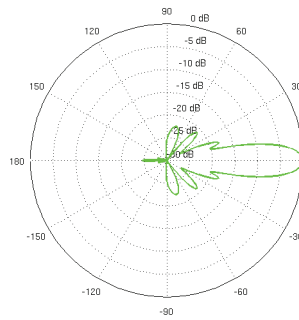

Vertical Elevation

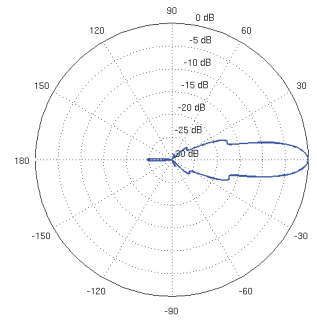

Horizontal Azimuth

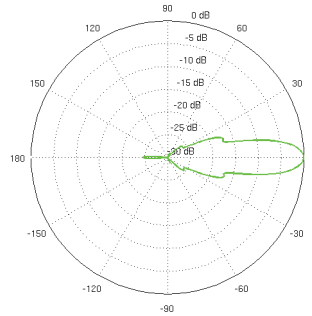

Horizontal Elevation

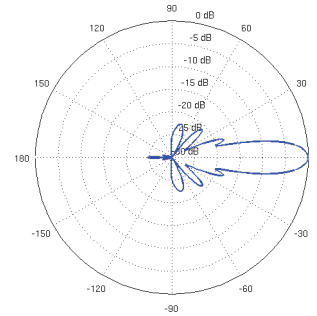

## RD-3G26 Antenna Information

Return Loss

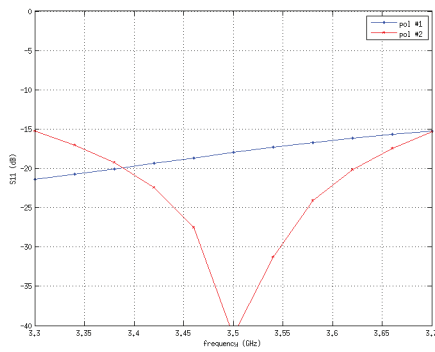

E-Plane, 3550 MHz

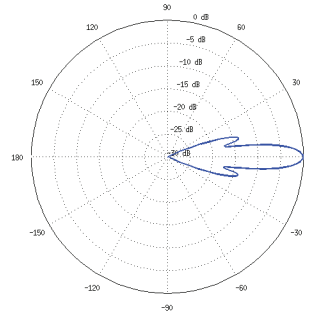

E-Plane Specs

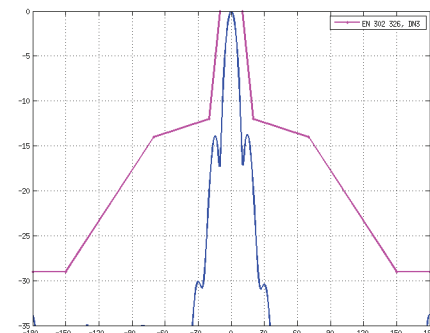

H-Plane, 3550 MHz

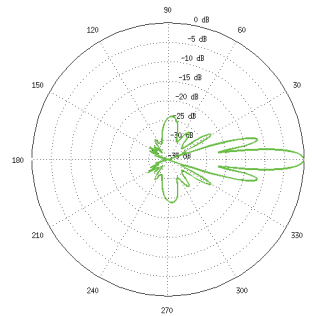

H-Plane Specs

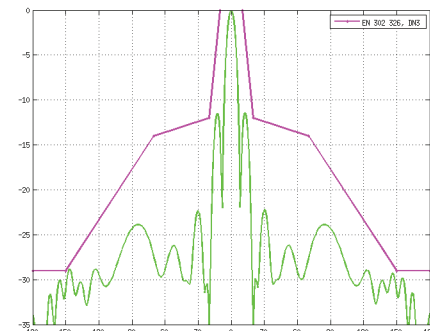

### RD-5G30 Antenna Information

E-Plane, 5500 MHz

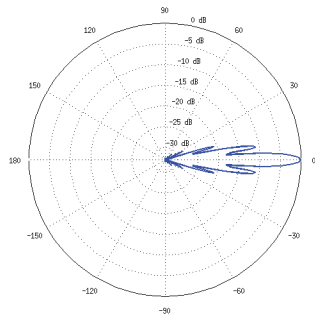

E-Plane Specs

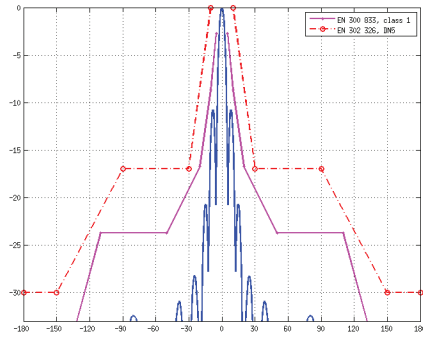

H-Plane, 5500 MHz

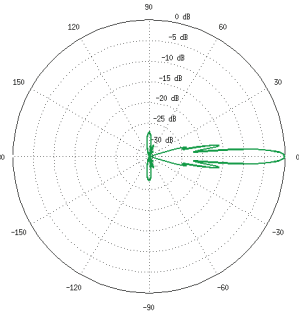

H-Plane Specs

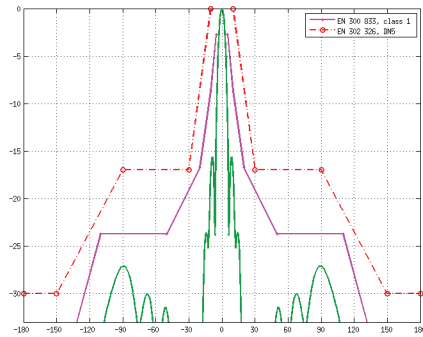

### RD-5G30-LW Antenna Information

Return Loss

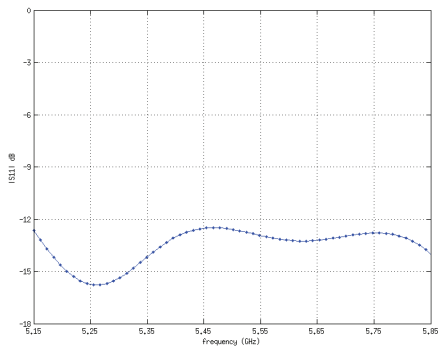

E-Plane, 5500 MHz

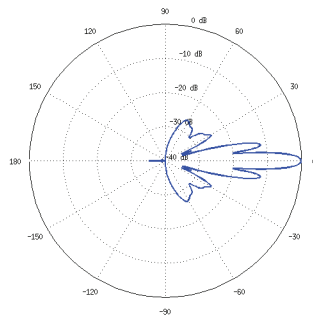

E-Plane Specs

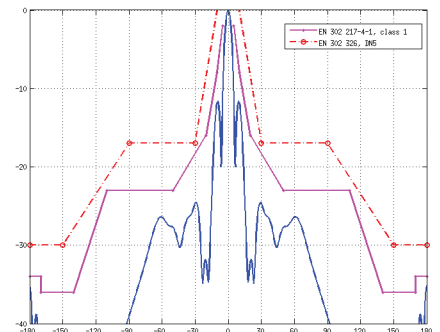

H-Plane, 5500 MHz

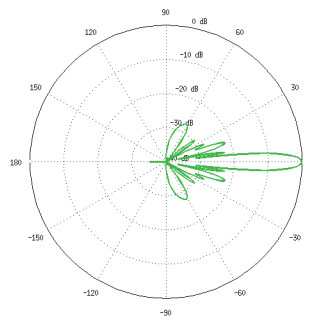

H-Plane Specs

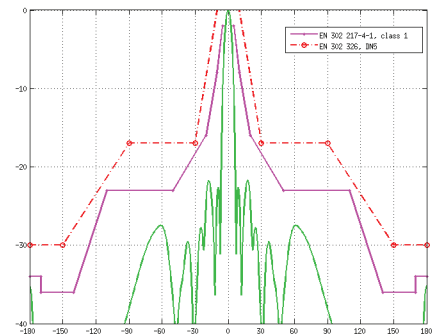

# RD-5G34 Antenna Information

E-Plane, 5500 MHz

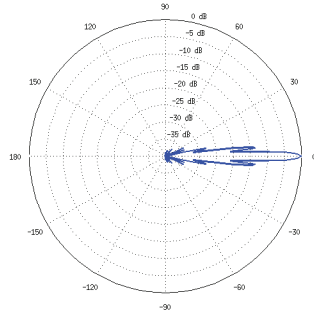

E-Plane Specs

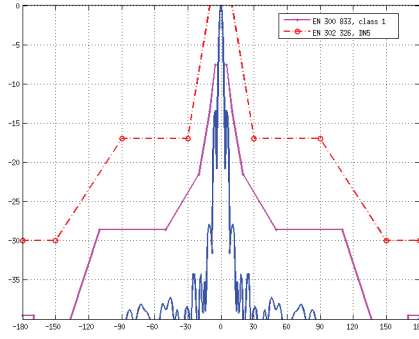

H-Plane, 5500 MHz

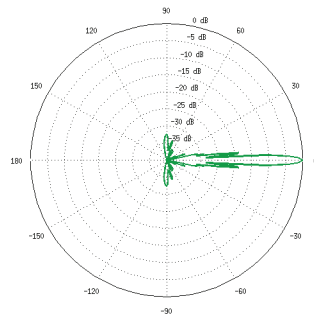

H-Plane Specs

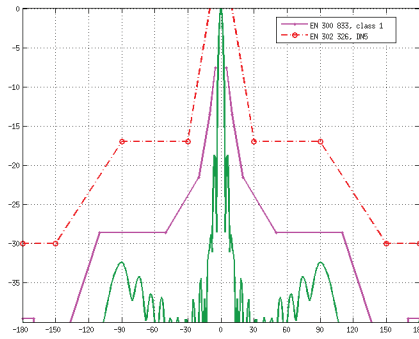

Specifications are subject to change. Ubiquiti products are sold with a limited warranty described at: [www.ubnt.com/support/warranty](http://www.ubnt.com/support/warranty)  
 ©2015-2016 Ubiquiti Networks, Inc. All rights reserved. Ubiquiti, Ubiquiti Networks, the Ubiquiti U logo, the Ubiquiti beam logo, airFiber, airMAX, airOS, IsoBeam, PowerBeam, Rocket, and RocketDish are trademarks or registered trademarks of Ubiquiti Networks, Inc. in the United States and in other countries. All other trademarks are the property of their respective owners.